



EUROPEAN COMMISSION

DIGIT
Connecting Europe Facility

SML

Service Offering Description

Version [1.08]

Status [Final]

© European Union, 2019

Reuse of this document is authorised provided the source is acknowledged. The Commission's reuse policy is implemented by Commission Decision 2011/833/EU of 12 December 2011 on the reuse of Commission documents.

Date: 15/05/2019

Document Approver(s):

Approver Name	Role
João RODRIGUES-FRADE	CEF eDelivery

Document Reviewers:

Reviewer Name	Role
FERIAL Adrien	CEF Technical Office
RODRIGUES FRADE João	CEF eDelivery
JOOSTEN Britt	CEF eDelivery

Summary of Changes:

Version	Date	Created by	Short Description of Changes
0.01	28/07/2016	CEF Support	Creation of the document
0.02	28/07/2016	CEF Support	Review of the created document
0.03	16/08/2016	CEF Support	Apply comments and Remarks
0.04	30/08/2016	CEF Support	Apply comments and Remarks
0.05	13/09/2016	CEF Support	Apply comments and Remarks
0.06	20/09/2016	FERIAL Adrien	Upgrade of the SML service taken into account
0.07	17/10/2016	FERIAL Adrien RODRIGUES FRADE João	Review and modifications
0.08	20/10/2016	CEF Support	Apply comments and Remarks
0.09	07/11/2016	CEF Support	Apply comments
1.00	10/11/2016	CEF Support	Update and validation of the document
1.01	17/11/2016	Britt Joosten	Final review
1.02	15/02/2017	CEF Support	Finalized the document
1.03	14/07/2017	CEF Support	Updated the links
1.04	24/01/2018	Caroline AEBY	Review, spelling mistakes correction.
1.05	05/02/2018	Flavio SANTOS	Review Dynamic Discovery
1.06	06/02/2018	Chaouki BERRAH and Caroline AEBY	Examples added
1.07	27/03/2018	CEF Support	Reuse policy notice added.
1.08	25/09/2018	Caroline AEBY	End of the standby service

Table of Contents

1. INTRODUCTION	4
1.1. Purpose of the service.....	5
1.2. Users.....	7
1.3. Scope	8
1.4. Benefits.....	8
2. ROLES AND RESPONSIBILITIES	9
2.1.1. Service Provider.....	10
2.1.2. CEF eDelivery Support.....	10
2.1.3. CEF eDelivery Technical Team.....	10
2.1.4. Policy domain Owner	10
3. HOW TO USE THE SERVICE STEP BY STEP	11
3.1. S1 - Creation of a CEF eDelivery DNS subdomain for Policy Domain Owners	11
3.1.1. Step 0: Prerequisite.....	11
3.1.2. Step 1: Registration	11
3.1.3. Step 2: Execution.....	12
3.1.4. Step 3: Create CEF eDelivery DNS subdomain	14
3.2. S2 - Management of SMPs and participants	15
3.2.1. Step 0: Prerequisite:.....	15
3.2.2. Step 1: Call the Web services exposed by SML/SMK	16
3.3. S3 – Operate and monitor SML Services	17
3.4. S4 - Maintenance.....	18
4. TERMS AND CONDITIONS.....	19
5. GLOSSARY	20
6. ANNEX 1 – DOCUMENT PARTS	21
7. CONTACT INFORMATION	22

1. INTRODUCTION

CEF eDelivery is based on a four-corner model in which the Backend systems exchange messages via [Access Points](#). The [CEF eDelivery Service Metadata Locator \(SML\)](#) enables a Sending Access Point to dynamically discover the IP address of the Receiving Access Point. Instead of looking at a static list of IP addresses, the Sending Access Point consults a [Service Metadata Publisher \(SMP\)](#) where information about every participant in a large message exchange infrastructure is kept up to date, including the IP addresses of the Access Point.

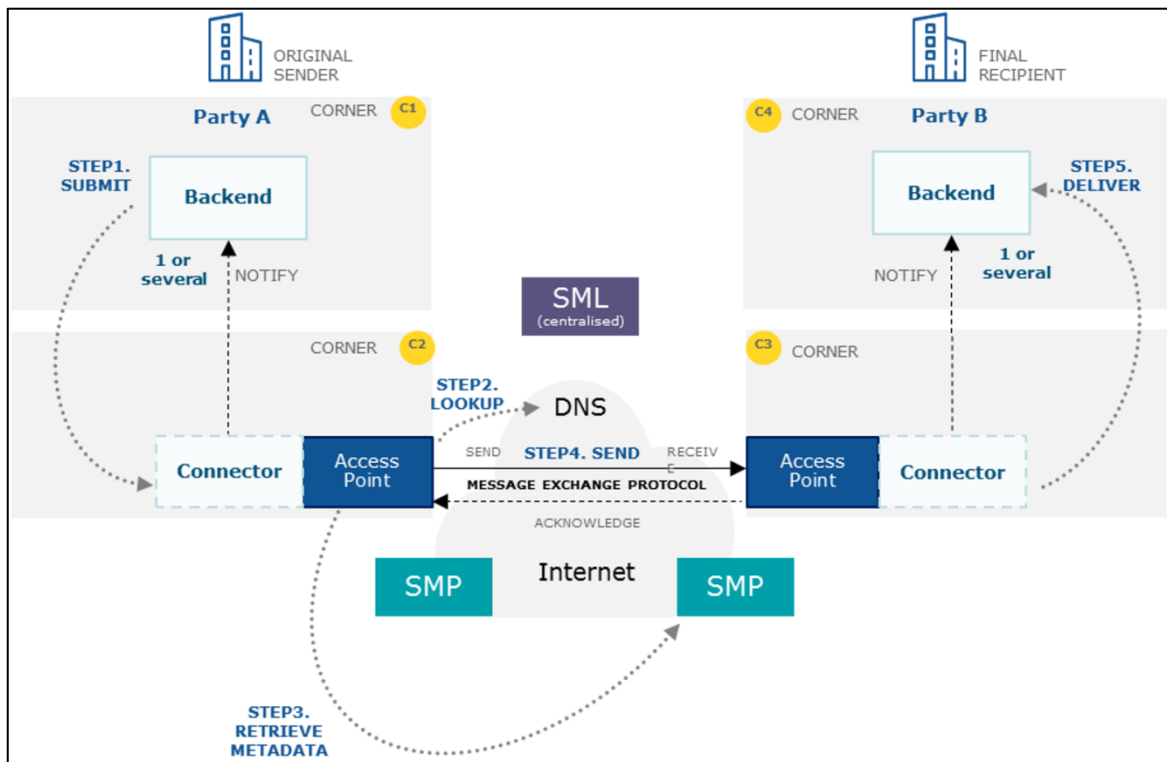

In addition to the Service Metadata Publisher (SMP), the Service Metadata Locator (SML) is the other key component that enables dynamic discovery of participants in message exchange infrastructures. The SML is used to create or update the resource records in the Domain Name System (DNS) so that the Access Points can discover the SMP of the receiving participant. As a result, these infrastructures can scale up without being affected by the management of an increasing number of participants. Instead of having to centrally manage a list of Access Points (known as 'static discovery') which all of them must be able to access and download, the discovery of participants becomes dynamic and possibly fully distributed and consequently much more scalable.

The current CEF eDelivery SML service implements both the [CEF eDelivery SML specifications](#) and the [PEPPOL Transport Infrastructure SML specifications](#). The CEF eDelivery SML Service uses a [sample implementation of the SML software](#) maintained by the European Commission.

1.1. Purpose of the service

For cross-border message exchange infrastructures to scale, the management of participants must become as dynamic and distributed as possible. Consequently, CEF eDelivery suggests a discovery system based on two components: a central SML and one or several SMPs. If several SMPs are used, then discovery becomes both dynamic and distributed. If a single SMP is used, then discovery becomes dynamic but centralised. Once these components are deployed, Access Points can discover each other by first consulting the metadata stored in a SMP. In eDelivery message exchange infrastructures with dynamic discovery, a sending Access Point consults the capabilities of the receiving Access Point published on a SMP to decide whether that Access Point is eligible and able to receive specific types of messages.

To use such a SMP, the sending Access Point needs to know its location. This happens by constructing a unique and standardised URL based on the resolution of a Domain Name in the Domain Name System (DNS). This is possible because each Participant must have their metadata exclusively registered within one SMP. The sending Access Point constructs the URL for retrieving the metadata for a given recipient participant identifier using a standard format:

The user has to first retrieve the list of Services.

Example:

```
http://test-infra.peppol.at/iso6523-actorid-upis%3A%3A9915%3Atest/.
```

Then the user has to access any one of the listed services using the following format:

```
http://<hash over  
recipientID>.<schemeID>.<policydomainname>.<smldomain>/<scheme>::<recipientId>/services/<do  
cumentTypes>
```

Example:

```
http://test-infra.peppol.at/iso6523-actorid-upis%3A%3A9915%3Atest/services/busdox-docid-  
qns%3A%3Aurn%3Aoasis%3Anames%3Aspecification%3Aubl%3Aschema%3Axsd%3AInvoice-  
2%3A%3AInvoice%23%23urn%3Awww.cenbii.eu%3Atransaction%3Abitrns010%3Aver2.0%3Aextend  
ed%3Aurn%3Awww.peppol.eu%3Aabis%3Apeppol4a%3Aver2.0%3Aextended%3Aurn%3Awww.erech  
nung.gv.at%3Aver1.0%3A%3A2.1
```

Consequently, each participant gets a unique URL for its metadata. The SML service can generate one CNAME record as well as one NAPTR¹ record per participant.

The SML uses the CNAME record type and creates domain names using the scheme *<hash over recipientID>.<schemeID>.<SML domain>*. The Domain Name is registered within a CNAME² record in the DNS.

As the CEF eDelivery SML Service implements the [Business Document Metadata Service Location](#) specification (BDXL), it is also possible for the sending Access Point to execute a NAPTR query to retrieve the metadata of the receiving Access Point.

¹ DNS NAPTR record is specified in [RFC 2915](#)

² DNS CNAME record is specified in [RFC 1034](#) and clarified in Section 10 of [RFC 2181](#)

An example of a DNS listing for participantId Value: dynceftestparty5gw is shown below:

```

participantScheme: connectivity-partyid-qns

Sub-domain: connectivitytest

Domain: acc.edelivery.tech.ec.europa.eu.

Domain: acc.edelivery.tech.ec.europa.eu.

NQU57KLCR67YZEXE0GLJNQSOZP202CT6DM7Q6DFPB3VVFYAU4DNM6A.connectivity-partid-
qns.connectivitytest.acc.edelivery.tech.ec.europa.eu. 60 IN NAPTR 100 10 "U" "Meta:SMP"
"!^.*$!http://40.115.23.114:38080/!" .
UGF55C50465A2ZXU6BTWNV3RJMVDJSDHTNF3V2GLCZE2HISSBVA.connectivity-partid-
qns.connectivitytest.acc.edelivery.tech.ec.europa.eu. 60 IN NAPTR 100 10 "U" "Meta:SMP"
"!^.*$!http://40.115.23.114:38080/!" .
USOCMLB3RWRWVAIELSG4NNHIVECX35XVZR5I2XCM6UUY7FLECBA.connectivity-partid-
qns.connectivitytest.acc.edelivery.tech.ec.europa.eu. 60 IN NAPTR 100 10 "U" "Meta:SMP"
"!^.*$!http://40.118.20.112:38080/smp!" .
B-c39e97893795f3c13306263056d902e9.connectivity-partyid-qns.connectivitytest.acc.edelivery.tech.ec.europa.eu.
C4J5QDPW5DFDR5GTRCDQGW4XAYX2WIFHKDUUQZ2XK325NBTLRSAA.connectivity-partyid-
qns.connectivitytest.acc.edelivery.tech.ec.europa.eu. 60 IN NAPTR 100 10 "U" "Meta:SMP"
"!^.*$!http://40.115.23.114:38080/!" .
B-adb4c6d3821d142c684b13ed269fad65.ehealth-actorid-qns.connectivitytest.acc.edelivery.tech.ec.europa.eu. 60
DALXF03CDYE5ZSLF5WAVCYQ3XGERI60NBUJ5WAH3T77THFWCGEQ.ehealth-actorid-
qns.connectivitytest.acc.edelivery.tech.ec.europa.eu. 60 IN NAPTR 100 10 "U" "Meta:SMP"
"!^.*$!http://40.115.21.208:7001/cipa-smp-full-webapp-4.0.0-RC1!" .
7KDEJXMHG7UHLIK7HDYXPJK2PY52PZK3RX37N252TMM7VCNF0A.ehealth-actorid-qns.ehealth.acc.edelivery.tech.ec.europa.eu.
7ZFKKK3YF4XIQVW54LC4FMJJ05BX3C6AA5YTMKLRKRSBLYUCINB7Q.ehealth-actorid-qns.ehealth.acc.edelivery.tech.ec.europa.eu.
ANXD5CSJJWLXESB5QB2MHJUX34ZU6MFFWQXRL4M4VHVO7XXY2A.ehealth-actorid-qns.ehealth.acc.edelivery.tech.ec.europa.eu.
B-02bac6cc4d7f0e99a3b9442e5f2d40a.ehealth-actorid-qns.ehealth.acc.edelivery.tech.ec.europa.eu. 60 IN
B-1c918b64390d2fd1456863d71c33a096.ehealth-actorid-qns.ehealth.acc.edelivery.tech.ec.europa.eu. 60 IN
    
```

The role of the SML is to manage the resource records of the participants and SMPs in the DNS. This means that dynamic discovery does not use a single central server to run the discovery interface, with its associated single point of failure, but uses DNS, instead, to make it highly resilient.

The deployment infrastructure of the CEF eDelivery SML Service relies on an internal DNS server configured with Domain Name System Security Extensions (DNSSEC). The records are then replicated in the public DNS. Since CEF eDelivery interfaces with the global DNS system, dynamic discovery can virtually operate 24/7/365.

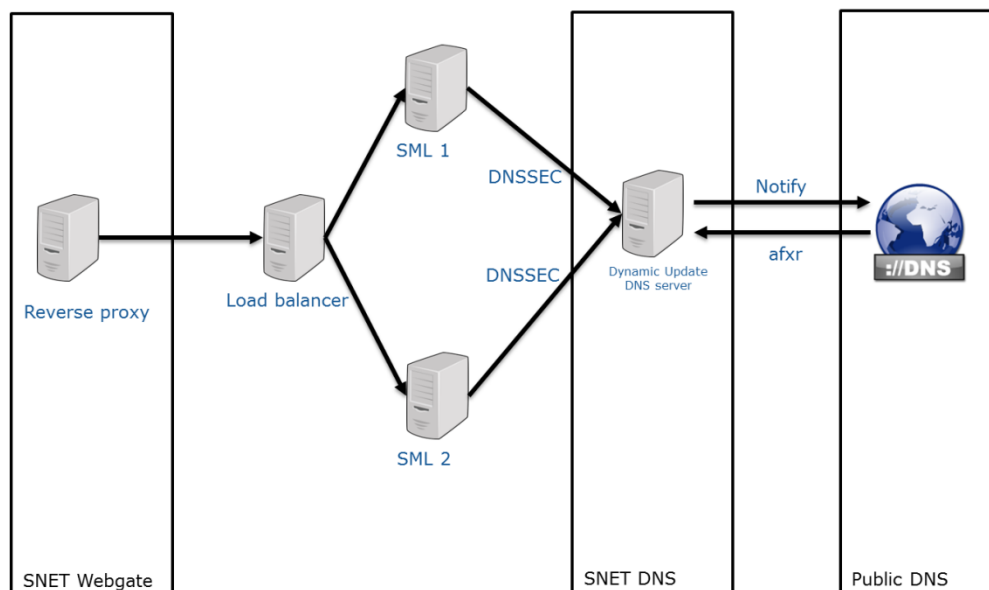

The CEF eDelivery SML Service is deployed on two different environments:

Terminology	Definition
SML	Service Metadata Locator (Production) Base URL for the environment is: SML - Production: https://edelivery.tech.ec.europa.eu/edelivery-sml/
SMK	Service Metadata locator (Acceptance). This environment will only be used for testing purposes. Base URL for the environment is: SMK - Acceptance: https://acc.edelivery.tech.ec.europa.eu/edelivery-sml/

1.2. Users

The CEF eDelivery SML service is intended for the following type of users:

- **Service Providers:** may offer services (such as SMP services) to integrate national backend systems with the CEF eDelivery SML Service or install and operate a CEF eDelivery SML Service.
- **Policy Domain Owners:** decide together with IT architects on whether to use dynamic or static discovery and whether to make it fully distributed or centralised.

1.3. Scope

Policy Domain Owners who subscribe to use SML Services will have their CEF eDelivery DNS subdomain. For example, e-Health is a Policy Domain and ehealth.edelivery.tech.ec.europa.eu is a CEF eDelivery DNS subdomain of e-Health. The scope of the CEF eDelivery SML Service is:

- Centrally operate the SML service as a 'shared service' to manage DNS records of the participants and SMPs in the DNS.
- Explain to the Policy Domain Owners the process of adding a new CEF eDelivery DNS subdomain.

CEF eDelivery Component	Description of the component	In scope of the service
Service Metadata Locator (SML)	<p>The CEF eDelivery Service Metadata Locator (SML) enables the Sending Access Point to dynamically discover the IP address of the Receiving Access Point. Instead of looking at a static list of IP addresses, known as static discovery, the sending Access Point consults a Service Metadata Publisher (SMP) to retrieve the IP addresses of the receiving Access Point. The specifications implemented are:</p> <ul style="list-style-type: none"> • SML specifications • SMP specifications 	<p>The Training and Deployment services are described in the Training and Deployment Service Offering Document</p>

1.4. Benefits

The CEF eDelivery SML Service has been designed to generate a list of benefits to the users of the service:

- Dynamic, global and centralized information management about the participant's SMP location on a Domain Name System (DNS) out of the box;
- Well established processes and procedures supported by the CEF eDelivery Support office;
- Scaling up of message exchange infrastructures with hundreds or even thousands of participants.

2. ROLES AND RESPONSIBILITIES

This section describes the main roles in the CEF eDelivery SML Service and their responsibilities.

The following table summarises the split of roles and responsibilities between the different actors in the CEF eDelivery SML Service process in the form of an RACI matrix where:

- **Responsible (R):** indicates the entities that perform the process-step. Every process-step has at least one responsible entity. Responsibilities can also be shared.
- **Accountable (A):** indicates the entity that is ultimately accountable for the process-step. Every process-step has only one accountable entity.
- **Consulted (C):** indicates the entities that give feedback or are consulted during the process-step. This is a two-way process. Not every process-step has an entity that is being consulted.
- **Informed (I):** indicates the entities that needs to be informed about the results of the process-step. This is a one-way process. Not every process-step has an entity that is being informed.

The services are described in detail in Section 3.

- S1 – Creation of a CEF eDelivery DNS subdomain for Policy Domain Owners
- S2 – Management of SMPs and participants
- S3 – Operate and monitor SML Services
- S4 – Maintenance

Service	Entity Role			
	Service Provider	CEF eDelivery Support	Policy Domain Owner	CEF eDelivery Technical Team
S1: Creation of a CEF eDelivery DNS subdomain for Policy Domain Owners				
Step 0: Prerequisite			RA	
Step 1: Registration		RA	R	
Step 2: Execution		RA	I	
Step 3: Create CEF eDelivery DNS subdomain		I		RA
S2: Management of SMPs and participants				
Step 0: Prerequisite	RA		R	
Step 1: Call the Web services exposed by the SML/SMK	R	AC		C
S3: Operate and monitor SML Services	I	RA		
S4: Maintenance	I	RA		

2.1.1. Service Provider

Role: User of the CEF eDelivery Service Metadata Locator (SML)

Responsibilities:

- Requests the services of the respective PKI service provider to get the valid certificates and identifier for the SMP.
- Set up the SMP to invoke the web services exposed by SML/SMK.

2.1.2. CEF eDelivery Support

Role: Second line support

Responsibilities:

- Register, classify, investigate, escalate if needed, resolve and close tickets.
- Manage the availability and capacity monitoring of the SML services.
- Act as the technical single point of contact to the Service Provider, Policy Domain Owner and provide support during the connection to the SML Services.

2.1.3. CEF eDelivery Technical Team

Role: Third line support and technical support

Responsibilities:

- Maintain the SML sample implementation.
- Create the CEF eDelivery DNS subdomain.

2.1.4. Policy domain Owner

Role: policy domain owner and first line support

Responsibilities:

- Request the service and provide the necessary information for the registration, planning and execution of the service.
- Provide first line support to the users for policy-related matters.
- Setup the PKI service and select a PKI service provider to deliver the certificates.

Provide the CEF eDelivery Support with the details (Name of the Project, Root CA).

3. HOW TO USE THE SERVICE STEP BY STEP

This section describes the processes that are part of the CEF eDelivery SML Service:

- S1 – Creation of a CEF eDelivery DNS subdomain for Policy Domain Owners
- S2 – Management of SMPs and participants
- S3 – Operate and monitor SML Services
- S4 – Maintenance

3.1. S1 - Creation of a CEF eDelivery DNS subdomain for Policy Domain Owners

The figure below presents an overview of the main steps of the creation of a CEF eDelivery DNS subdomain for Policy Domain Owners process. Each of the process steps is described in more detail in the next sections.



3.1.1. Step 0: Prerequisite

For SML, it is assumed that the Policy Domain Owners have already passed the acceptance tests.

Purpose: To make sure that the acceptance (SMK) tests are successful before going in SML Production.

Actors:

- Policy Domain Owner (e.g. OpenPEPPOL)

3.1.2. Step 1: Registration

Purpose: Register the service request and exchange the necessary information and documentation to set up a new CEF eDelivery DNS subdomain on the SML.

Actors:

- Policy Domain Owner
- CEF eDelivery Support

Process:

1. The Policy domain owner sends a secured email ([SECEM](#)) to the CEF eDelivery Support to request the CEF eDelivery DNS subdomain in SML/SMK. The request should contain the following information:
 - Project Name
 - Details on the trusted root certificate authority
2. The CEF eDelivery Support registers the service request.

3. The CEF eDelivery Support provides information and documentation to the Policy Domain Owner. This information includes:
 - SLA Manager Service Document
 - Interface Control Document
 - SML Service Offering Description (this document)

The overview of the set-up process is shown in the diagram below.

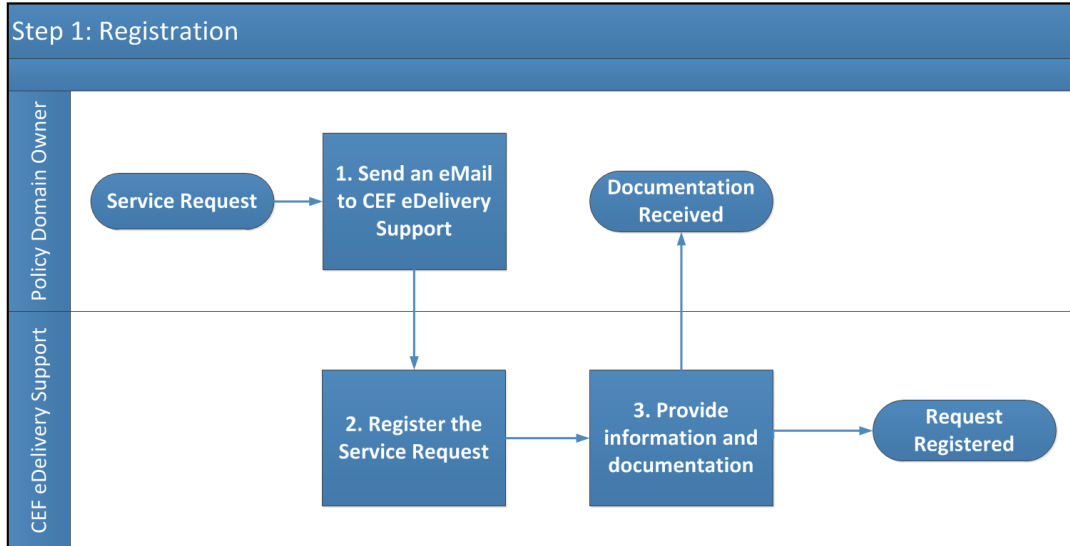

3.1.3. Step 2: Execution

Purpose: Execute the request for adding a new CEF eDelivery DNS subdomain.

Actors:

- CEF eDelivery Support
- CEF eDelivery Technical Team

Process:

1. Escalate the request to the CEF eDelivery Technical Team for the new CEF eDelivery DNS subdomain activation.

The overview of the Process Request process is shown in the diagram below.

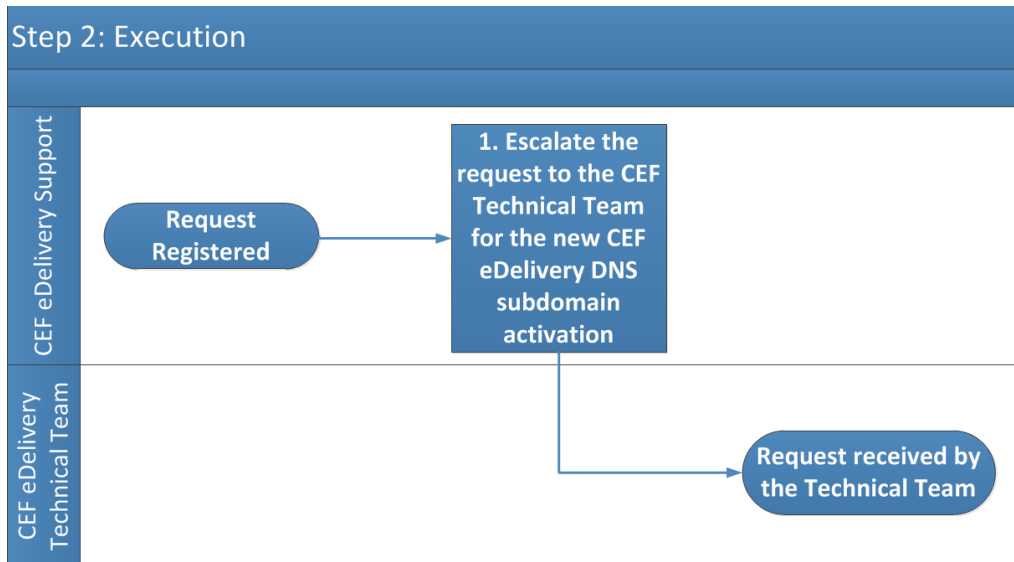

3.1.4. Step 3: Create CEF eDelivery DNS subdomain

Purpose: To activate the new CEF eDelivery DNS subdomain of the Policy Domain Owner.

Actors

- CEF eDelivery Technical Team
- CEF eDelivery Support

Process:

1. Resolution of the Request by the CEF eDelivery Technical Team.
2. The CEF eDelivery Technical Team informs the CEF eDelivery Support of the resolution of the request.
3. The CEF eDelivery Support informs the Policy Domain Owner.

The overview of the create CEF eDelivery DNS subdomain process is shown in the diagram below.

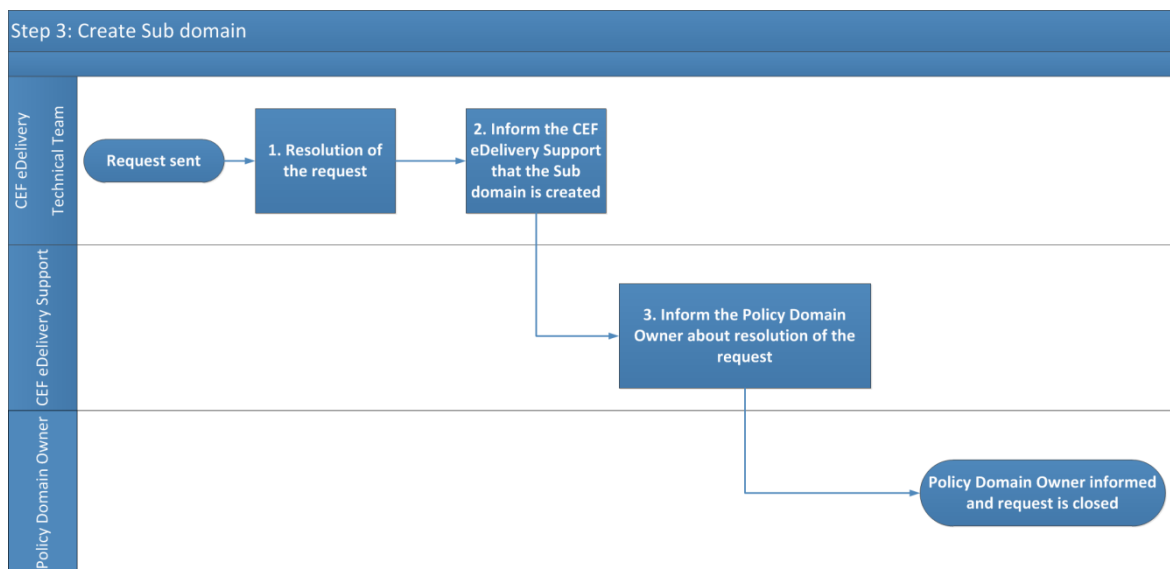

3.2. S2 - Management of SMPs and participants.

The diagram below represents an overview of the main steps of the Management of SMPs and participant's process. The process is described in detail in the following section.



3.2.1. Step 0: Prerequisite:

It is assumed that the Service Providers already have the valid certificate(s) and Identifier for SMP.

The Service Provider has to contact the Policy Domain Owner to get the certificate(s).

Purpose: Register the Service Provider with corresponding Policy Domain Owner and get the certificates for respective environment (Production – SML, Acceptance – SMK).

Actors:

- Service Provider
- Policy Domain Owner (e.g. OpenPEPPOL)

3.2.2. Step 1: Call the Web services exposed by SML/SMK

Purpose:

- To create, read, update or delete SMP in SML/SMK.
- To create, create list, delete, delete list, prepare to migrate Participant in SML/SMK.

Actors:

- Service Provider
- CEF eDelivery Support

Process:

1. Call the web services exposed by SML/SMK (for more details see the [Interface Control Document for SML](#)).
2. Contact the CEF eDelivery Support, by e-mail or by phone, in case of an issue (*See Contact Information*):
 - CEF eDelivery Support creates a ticket.
 - CEF eDelivery Support provides the required support/documentation to the Service Provider.
3. If the operation is successful, the DNS is updated.

The overview of the process Call to the Web services exposed by SML/SMK as shown in the diagram below.

The CEF eDelivery Support is available for any technical question.

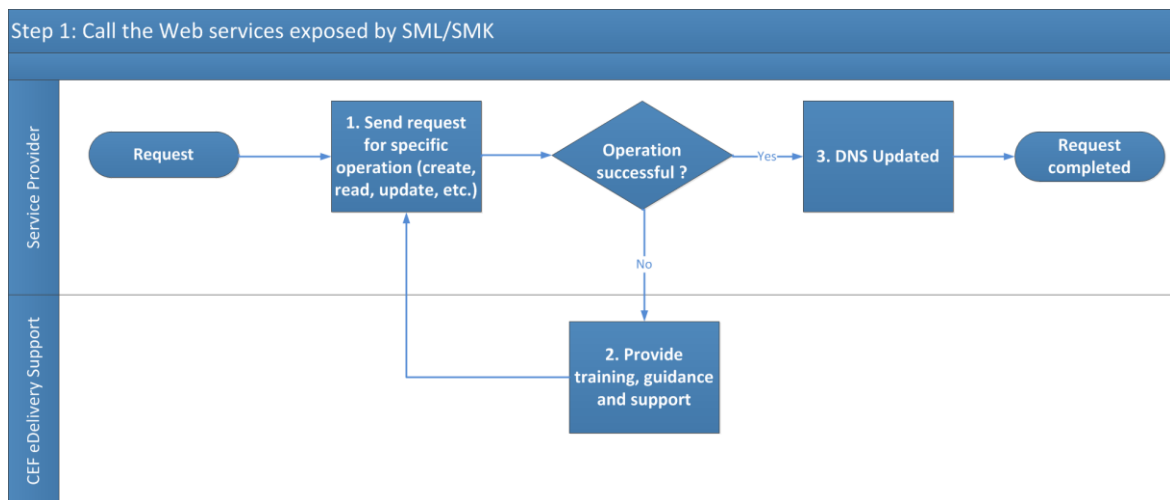

3.3. S3 – Operate and monitor SML Services

Purpose: Operate and monitor the CEF eDelivery SML Service.

Actors:

- Service Provider
- CEF eDelivery Support

Process:

1. Check and verify the availability and capacity of the CEF eDelivery SML Services through continuous automated monitoring.
2. Incidents and problems detected during the monitoring process are captured and handled through the [Service Desk process](#).
3. Inform the Service Provider in case the Service is not available because of an unplanned maintenance.
4. Inform the Service Provider as soon as the Service is available again.

Remark:

Check the [SML Service Level Arrangement](#) for more detailed information regarding the Service Level Targets to the CEF eDelivery Service SML Service.

The overview of the Monitoring process is shown in the diagram below:

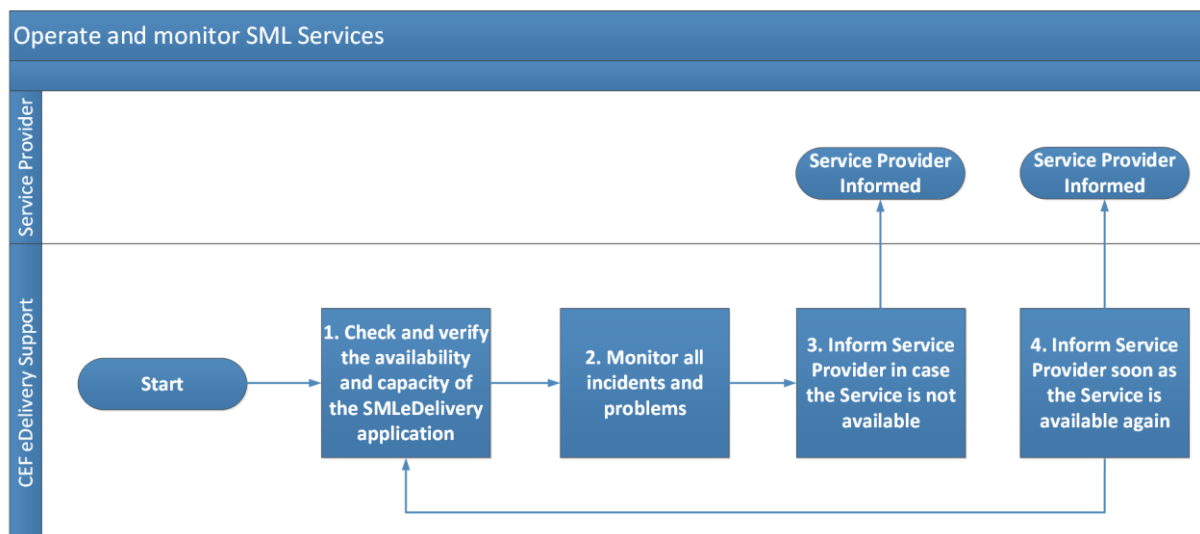

3.4. S4 - Maintenance

Purpose: Maintenance of the CEF eDelivery Service.

Actors:

- Service Provider
- CEF eDelivery Support

Process:

1. CEF eDelivery Support receives, internally, information regarding a planned maintenance.
2. Inform the User of the planned maintenance.

Remark:

Check the [SML Service Level Arrangement](#) for more detailed information regarding the Service Level Targets to the CEF eDelivery Service SML Service.

The overview of the Maintenance process is shown in the diagram below:

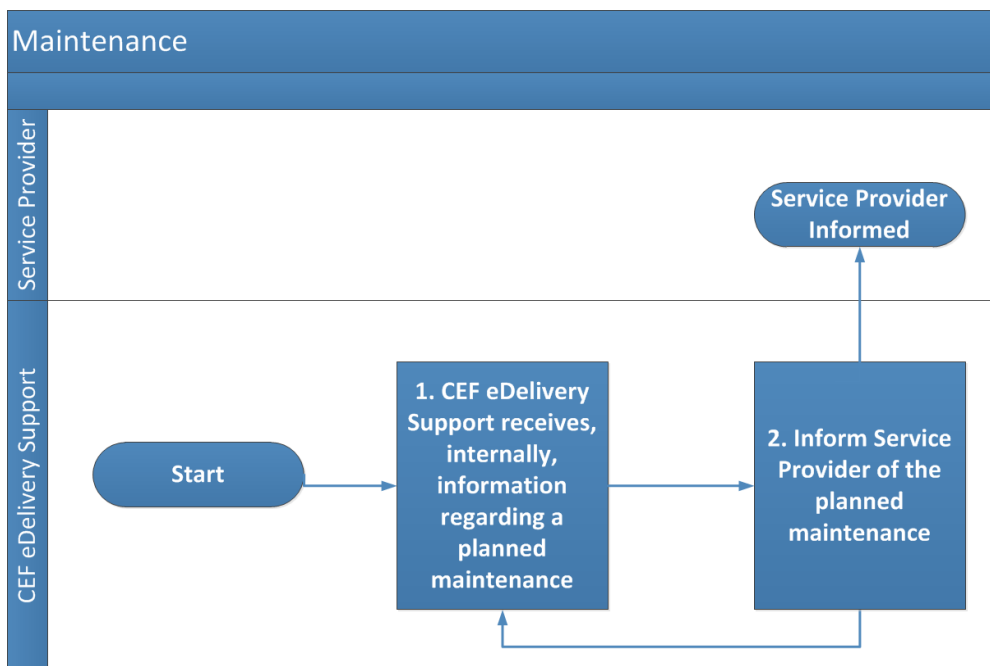

4. TERMS AND CONDITIONS

The general terms and conditions of CEF Building Blocks can be consulted in the Master Service Arrangement, available on the CEF Digital Single Web Portal:

<https://ec.europa.eu/cefdigital/wiki/x/DAiZAQ>

The terms and conditions specific to the CEF eDelivery SML Service are described in the table below.

Term / Condition	Description
Obligations of the Service Provider and Service Domain Owner	It is the responsibility of the Client to ensure that sufficient information and documents are given in due time to enable the required services to be performed; But also to make sure the prerequisites are met.
Delivery of the services	<p>The European Commission will provide the SML services using reasonable care and skill and in accordance with the technical specifications and procedures outlined in this document.</p> <p>The timing of completion of the CEF eDelivery SML services is based on best effort.</p> <p>The European Commission is entitled to suspend or terminate the provision of the services in case of failure of the Client to comply with its obligations, as described above, or any other conditions preventing the successful delivery of the service.</p>

5. GLOSSARY

The key terms used in this Component Offering Description are defined in the CEF Definitions section on the CEF Digital Single Web Portal:

<https://ec.europa.eu/cefdigital/wiki/display/CEFDIGITAL/CEF+Definitions>

The key acronyms used in this Component Offering Description are defined in the CEF Glossary on the CEF Digital Single Web Portal:

<https://ec.europa.eu/cefdigital/wiki/display/CEFDIGITAL/CEF+Glossary>

6. ANNEX 1 – DOCUMENT PARTS



Process Overview - P1.vsd



Registration.vsd



Execution.vsd



Create Subdomain.vsd



Process Overview - P2.vsd



Call WebServices.vsd



Monitoring.vsd



Maintenance.vsd

7. CONTACT INFORMATION

CEF Support Team

By email: CEF-EDELIVERY-SUPPORT@ec.europa.eu

Support Service: 8am to 6pm (Normal EC working Days)